

TOOL KIT

The tool kit (1) is in the tool box under the seat (page 46).

Some roadside repairs, minor adjustments and parts replacement can be performed with the tools contained in the kit.

- 8 mm Open end wrench
- 10 × 12 mm Open end wrench
- 10 × 14 mm Open end wrench
- 5 mm Hex wrench
- 22 mm Box end wrench
- 27 mm Box end wrench
- Spark plug wrench
- No. 2 phillips screwdriver
- No. 2 screwdriver
- Screwdriver grip
- Pin spanner
- Extension bar
- Pliers
- Helmet holder wire
- Tool bag

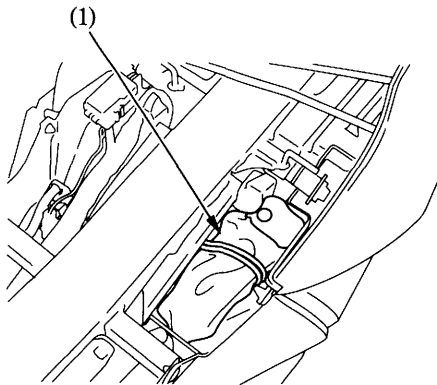

(1) Tool kit