

FUEL

Fuel Tank

The fuel tank capacity including the reserve supply is:

18.0 l (4.76 US gal , 3.96 Imp gal)

To open the fuel fill cap (1), insert the ignition key (2) and turn it clockwise. The fuel fill cap is hinged and will lift up.

Do not overfill the tank. There should be no fuel in the filler neck (3).

After refueling, to close the fuel fill cap, push the fuel fill cap into the filler neck until it snaps closed and locks. Remove the key.

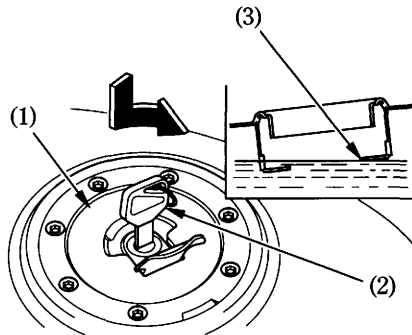

- (1) Fuel fill cap
(2) Ignition key

- (3) Filler neck

⚠ WARNING

Petrol is highly flammable and explosive. You can be burned or seriously injured when handling fuel.

- Stop the engine and keep heat, sparks, and flame away.
- Refuel only outdoors.
- Wipe up spills immediately.