

RIGHT HANDLEBAR CONTROLS

< For AUSTRALIA only >

Engine Stop Switch

The engine stop switch (1) is next to the throttle grip. When the switch is in the

○ (RUN) position, the engine will operate. When the switch is in the ☒ (OFF) position, the engine will not operate. This switch is intended primarily as a safety or emergency switch and should normally remain in the ○ (RUN) position.

Starter Button

The starter button (2) is below the engine stop switch (1).

When the starter button is pressed, the starter motor cranks the engine. If the engine stop switch is in the ☒ (OFF) position, the starter motor will not operate. See page 50 for the starting procedure.

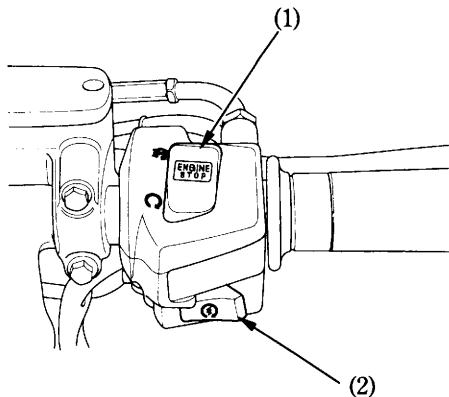

- (1) Engine stop switch
- (2) Starter button