

BRAKES

Both the front and rear brakes are the hydraulic disc types.

As the brake pads wear, the brake fluid level drops.

There are no adjustments to perform, but fluid level and pad wear must be inspected periodically. The system must be inspected frequently to ensure there are no fluid leaks. If the brake lever or pedal free travel becomes excessive and the brake pads are not worn beyond the recommended limit (page 128), there is probably air in the brake system and it must be bled. See your Honda dealer for this service.

Front Brake Fluid Level:

With the motorcycle in an upright position, check the fluid level. It should be between the UPPER (1) and LOWER (2) level marks. If the level is at or below the LOWER level mark, check the front brake pads for wear (page 128).

Worn pads should be replaced. If the pads are not worn, have your brake system inspected for leaks.

The recommended brake fluid is Honda DOT 4 brake fluid from a sealed container, or an equivalent.

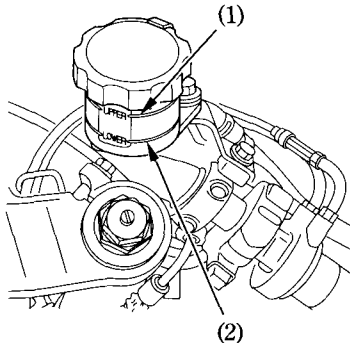

- (1) UPPER level mark
- (2) LOWER level mark