

Fuse box:

The fuse box is located under the front seat.

The specified fuses are:

10A , 20A

1. Remove the front seat (page 53).
2. Open the fuse box cover (1).
3. Pull out the old fuse and install a new fuse.
The spare fuse (2) are located in the fuse box.
4. Close the fuse box cover and install the front seat.

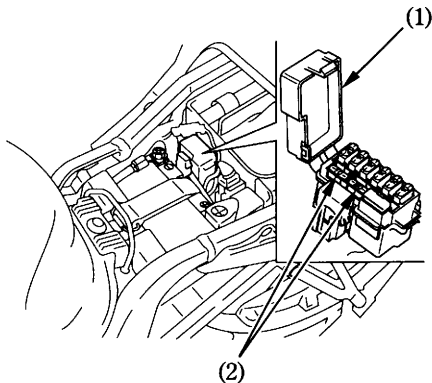

- (1) Fuse box cover
(2) Spare fuses