

Refer to *Safety Precautions* on page 45.

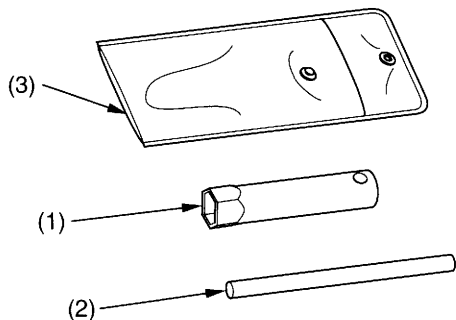

- (1) spark plug wrench
- (2) handle
- (3) tool bag

The spark plug wrench (1) and its handle (2) are stored in the tool bag (3) delivered with your motorcycle.

You will need to provide your own tools to perform any owner maintenance other than removing the spark plug.