

## Recoil Starter

The recoil starter (Fig. 2-8 ) is on the left side of the FOURTRAX. It is used to start the engine when the battery is low.

To operate the recoil starter:

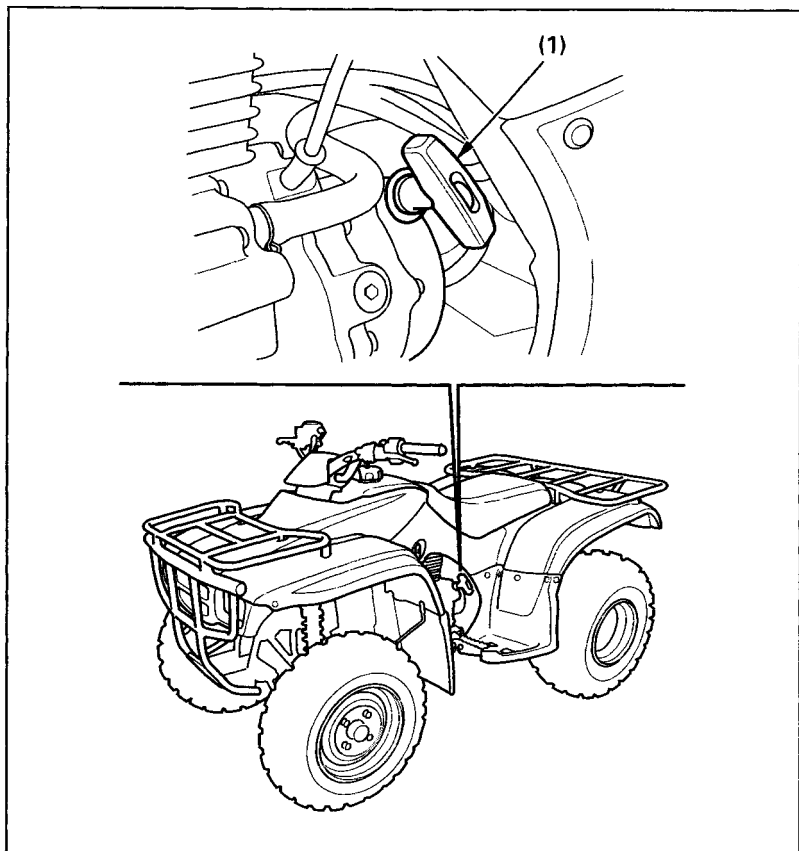

Fig. 2-8

(1) Recoil starter grip