

Air Cleaner

12. Install the air cleaner on the air cleaner body.
13. Apply a thin coat of grease to the sealing surface of the air cleaner assembly.
14. Install the clamp.
15. Insert the air cleaner assembly into the air cleaner housing.
16. Fasten the screws.

Dust Cover

UNDER SEAT

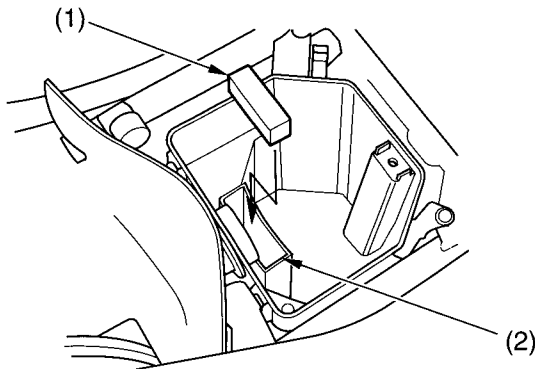

(1) dust cover

(2) air cleaner housing

Do not push the dust cover (1) too far into the air cleaner housing (2).
If the dust cover is dirty, clean it.