

2. Remove the inspection hole plug (2).
3. Measure the lining thickness (3) on both front wheels:
Standard: 0.16 in (4.0 mm)
Service Limit: 0.08 in (2.0 mm)

If either lining is worn beyond the limit, both brake shoes must be replaced by your Honda dealer.

4. If the brake lever freeplay and the brake shoe lining thickness are within the recommended limits, reinstall the inspection hole plugs, seating them into the inspection hole as shown.
5. If the brake lever freeplay is excessive but the linings are not worn beyond the service limit, adjust the brake lining clearance.

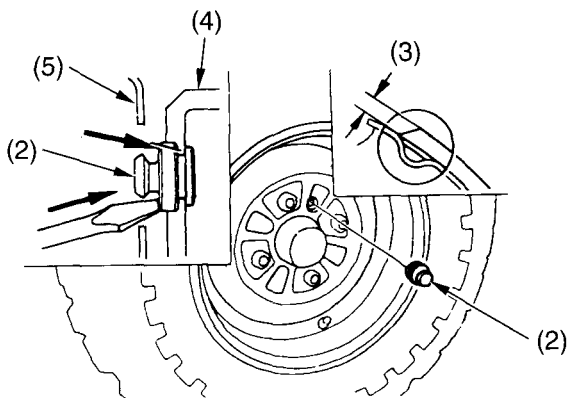

(2) inspection hole plug
(3) lining thickness

(4) front brake drum
(5) front wheel rim