

If a Fuse Blows

Main Fuse Access

UNDER SEAT

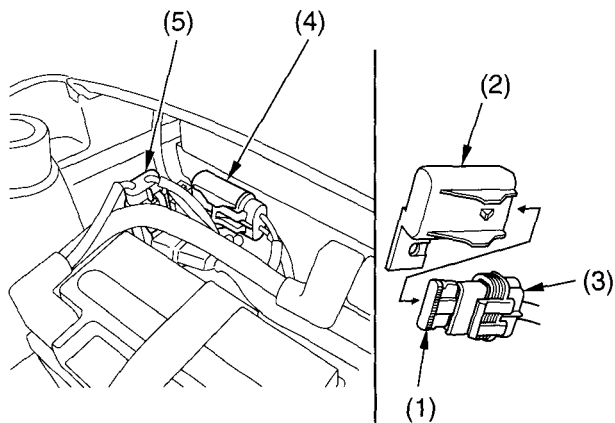

(1) fuse

(2) fuse holder assembly

(3) fuse holder

(4) main fuse holder assembly

(5) shift control motor holder
assembly

1. To prevent an accidental short circuit, turn the ignition switch OFF (\bigcirc) before checking or replacing the fuses.
2. To access the fuse (1), remove the seat (page 94).
3. Remove the fuse holder assembly (2).
4. Pull the old fuse out of the fuse holder (3).
5. Push the new fuse in to the fuse holder.
6. Install the fuse holder assembly and seat.

(cont'd)