

Controls & Features

Recoil Starter

LEFT SIDE

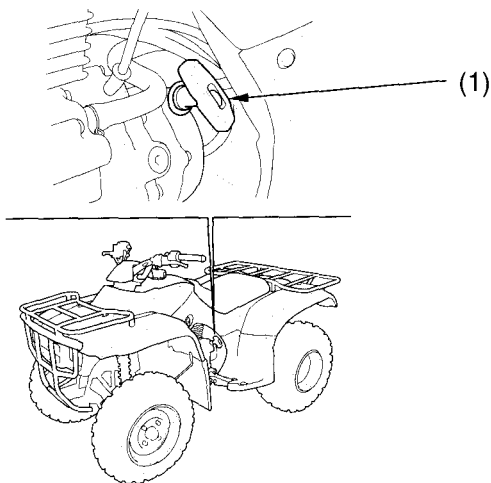

(1) recoil starter

The recoil starter (1) is used to start the engine when the battery is low.
See *Using the Recoil Starter*, page 51 .