

FUSES

As illustrated in Fig. 4-19, the main fuse (1), the sub fuse (2) and the spare fuse (3) are located in the battery compartment. Both the main fuse and the sub fuse are 15 A. (The main fuse is connected to the red wire.)

If a fuse fails frequently, it usually indicates a short circuit or an overload in the electrical system. See your authorized Honda dealer for repair.

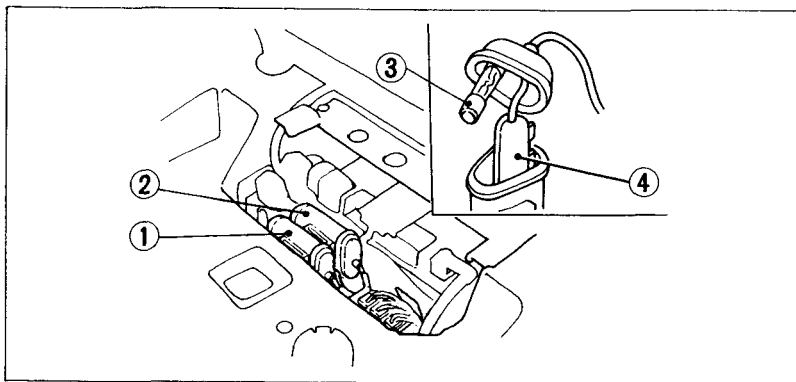

Fig. 4-19 (1) Main fuse (Red wire) (3) Spare fuse
(2) Sub fuse (Pink wire) (4) Fuse holder

To replace a fuse:

1. Make sure the ignition switch is OFF.

CAUTION:

Turn the ignition switch OFF before checking or replacing the fuse to prevent accidental short-circuiting which could damage the electrical system.