

Fig. 2-22 (1) Trailer hitch (2) An example ball

Storage Compartment

The storage compartment (Fig. 2-23) is behind the seat. To open the compartment, unhook the rubber straps (3) and lift the rear rack (4). The owner's manual (5), tool kit (6), and air pressure gauge (7) should be stored in the storage compartment (2).

Be careful not to flood this area when washing your FOURTRAX or riding through water.

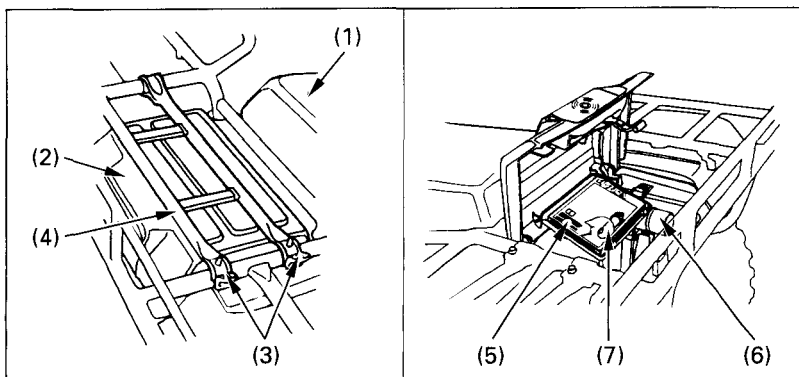

Fig. 2-23 (1) Seat (2) Storage compartment (3) Rubber straps (4) Rear rack (5) Owner's manual (6) Tool kit (7) Air pressure gauge