

Reverse Lock System

Measure the reverse assist lever (2) free play. Free play, measured at the lever (2) end near the cable (Fig. 4-16), should be approximately:
1/16–3/16 in (2–4 mm)

To adjust the free play:

Slide the rubber sleeve (3) back to expose the adjusting nut (4).

Loosen the lock nut (5) and turn the adjusting nut to obtain the correct free play.

Tighten the lock nut and reinstall the sleeve.

Other Checks:

Check the reverse assist lever and cable for loose connections or other damage. If the cable is worn or kinked, have it replaced by your Honda dealer.

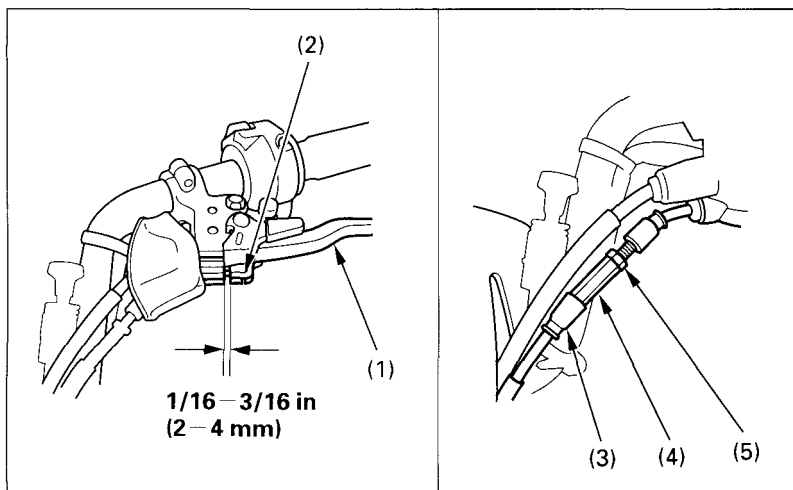

Fig. 4-16

(1) Rear brake lever
(2) Reverse assist lever

(3) Rubber sleeve
(4) Adjusting nut
(5) Lock nut

While reading this manual, remember:

▲WARNING

Indicates a strong possibility that serious injury or death may result if instructions are not followed.