

- (16) Rear brake fluid reservoir
- (17) Front brake fluid reservoir
- (18) Rear brake pedal
- (19) Operator footpeg

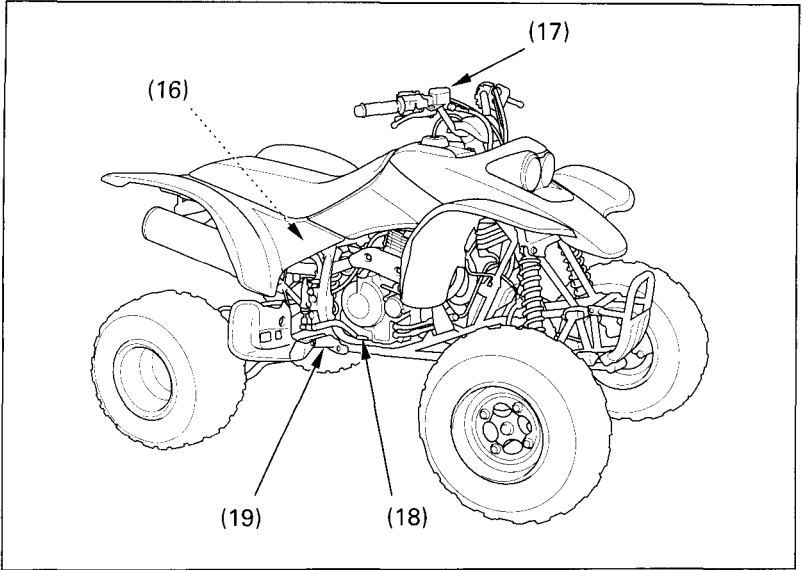

Fig. 2-3

Right side of Sportrax