

Throttle Lever

The throttle lever (Fig. 2-12) is next to the right handgrip, and it is operated by the thumb. Pressing the lever opens the throttle. When pressure is released, spring tension automatically closes the throttle.

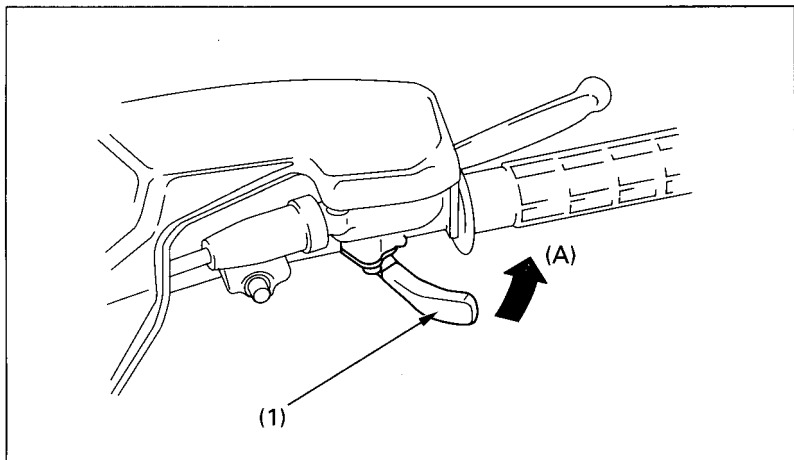

Fig. 2-12 (1) Throttle lever

(A) To open the throttle