

Starting Primer Knob

The starting primer knob (Fig. 2-9) is on the carburetor float bowl on the left side of the FOURTRAX. To start the engine when air temperature is below -15°C (5°F), push the knob in two or three times before pressing the starter button.

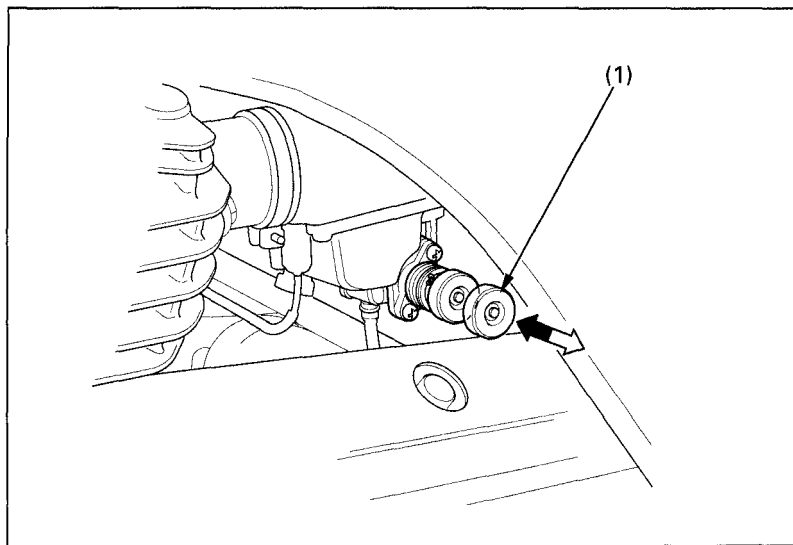

Fig. 2-9

(1) Starting primer knob