

Controls & Features

Starting Primer Knob

RIGHT SIDE

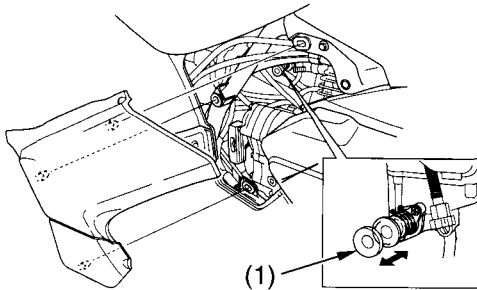

(1) starting primer knob

The starting primer knob (1) is located on the carburetor float bowl. The knob may be used when starting the engine in extremely cold weather (-15°C , 5°F). See *Starting Procedure*, page 65 .

Recoil Starter

RIGHT SIDE

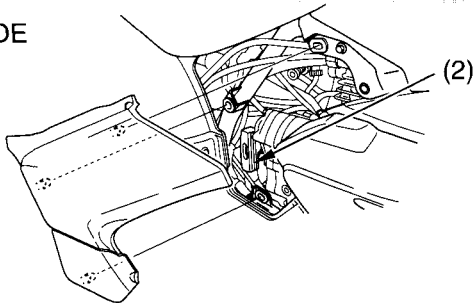

(2) recoil starter

The recoil starter (2) is used to start the engine when the battery is low. See *Using the Recoil Starter*, page 69 .