

# Driveshaft Boots

---

Refer to *Safety Precautions* on page 95.

FRONT

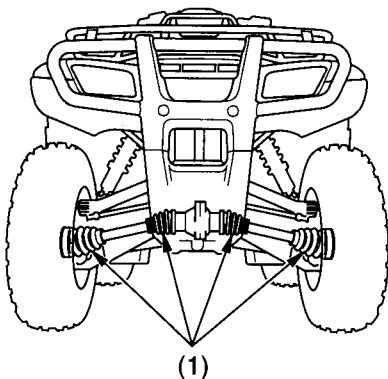

(1) driveshaft boots

Check the rubber driveshaft boots (1) for damage or leaking grease. If necessary, have your Honda dealer replace them.