



Scraper

Refer to *Safety Precautions* on page 77.

The knuckle scraper protects the rear lower arm and rear knuckle, and also scrapes mud from inside of the rear wheel rims.

The knuckle scraper wear will depend upon the severity of usage and riding conditions. The knuckle scraper will wear faster in wet or muddy conditions.

RIGHT REAR
(Left side similar)

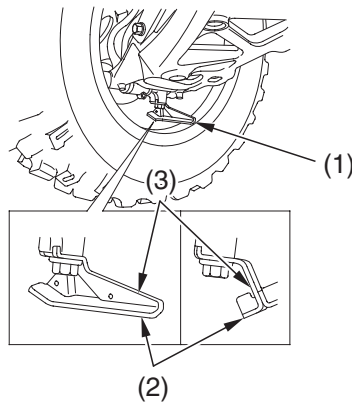

(1) knuckle scraper
(2) wear limit point

(3) vertical wall surface

Inspection

Check the knuckle scraper (1) for cracks, damage, worn or looseness at intervals specified in the Maintenance Schedule.

If the knuckle scraper is cracked or damaged, or if the wear limit point (2) reaches to the vertical wall surface (3), the knuckle scraper must be replaced, see your Honda dealer for this service.

Always inspect each scraper on both rear wheels.