

# Brakes

1. Apply the brake control (lever and pedal) and check the movement of the arrow (1) on the brake arm (2).
2. Replace the brake shoe if the arrow aligns with the reference mark (3) on the brake panel upon full application of the brake. If replacement is necessary, see your dealer.

## Draining Water from Brakes

Refer to *Safety Precautions* on page 94.

### REAR

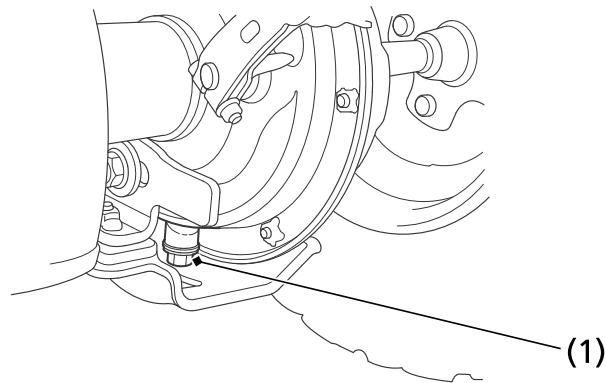

(1) rear brake drain bolt

1. Make sure the engine is off and the parking brake is set.
2. Remove the rear brake drain bolt (1) from the bottom of the rear brake panel.  
If any water drains, see your dealer as soon as possible for a check of the rear brake system and the left crankcase cover for water intrusion.