

### Battery Removal:

1. Remove the seat (page 39).
2. Release the rings and remove the rubber band (1).
3. Disconnect the negative (-) terminal lead (2) from the battery first, then disconnect the positive (+) terminal lead (3).
4. Pull out the battery (4) from the battery box.

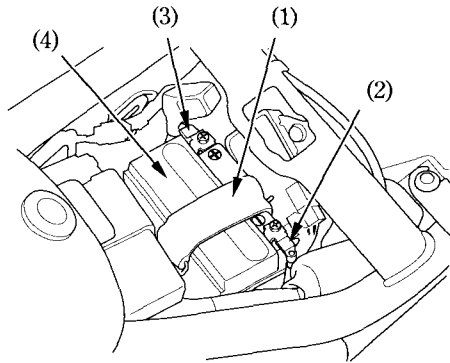

- (1) Rubber band
- (2) Negative (-) terminal lead
- (3) Positive (+) terminal lead
- (4) Battery