

### Removal:

1. Make sure the ignition switch is OFF.
2. Remove the seat (page 52).
3. Unhook the band (1) and remove the owner's manual (2).
4. Remove the battery cover (3) by removing the screw (4).

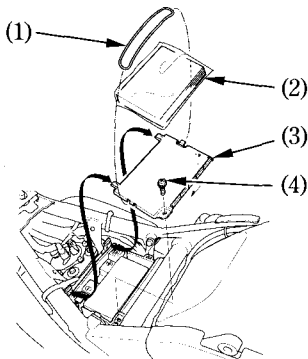

- (1) Band  
(2) Owner's manual  
(3) Battery cover  
(4) Screw

5. Disconnect the negative (-) terminal lead (5) from the battery first, then disconnect the positive (+) terminal lead (6).
6. Open the battery box cover (7).
7. Pull out the battery (8) from the battery box.

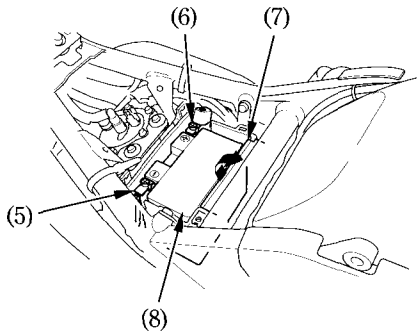

- (5) Negative (-) terminal lead  
(6) Positive (+) terminal lead  
(7) Battery box cover  
(8) Battery