

## Brake Light/Taillight Bulb

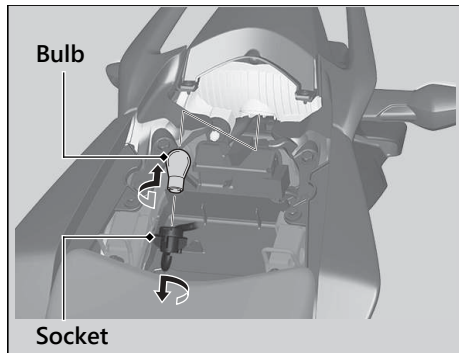

1. Remove the rear seat. ► P. 58
2. Turn the socket counterclockwise, and remove it.
3. Slightly press the bulb in and turn it counterclockwise.
4. Install a new bulb and parts in the reverse order of removal.
5. Install the rear seat.

## Front/Rear Turn Signal Bulb

1. Remove the screw A and screw B.
2. Remove the turn signal lens and lens packing.
3. Slightly press the bulb and turn it counterclockwise.

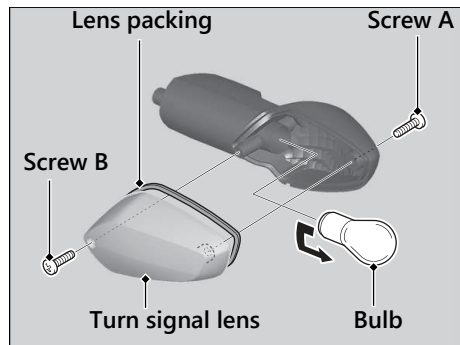

4. Install a new bulb in the reverse order of removal.
  - Use only the amber bulb.