

Adding Engine Oil

If the engine oil is below or near the lower level mark, add the recommended engine oil.

► P. 44, ► P. 126

1. Remove the oil fill cap. Add the recommended oil until it reaches the upper level mark.
 - Place your motorcycle in an upright position on a firm, level surface when checking the oil level.
 - Do not overfill above the upper level mark.
 - Make sure no foreign objects enter the oil filler opening.
 - Wipe up any spills immediately.

2. Securely reinstall the oil fill cap.

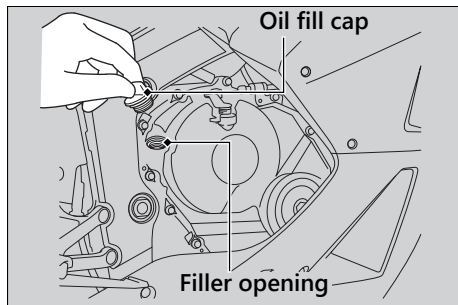

NOTICE

Overfilling with oil or operating with insufficient oil can cause damage to your engine. Do not mix different brands and grades of oil. They may affect lubrication and clutch operation.

For the recommended oil and oil selection guidelines, see "Maintenance Fundamentals."

► P. 44