

## Engine Oil ► Changing Engine Oil & Filter

- Remove the oil filter with a filter wrench and let the remaining oil drain out. Make sure the prior seal is not stuck to the engine.
  - Discard the oil and oil filter at an approved recycling center.

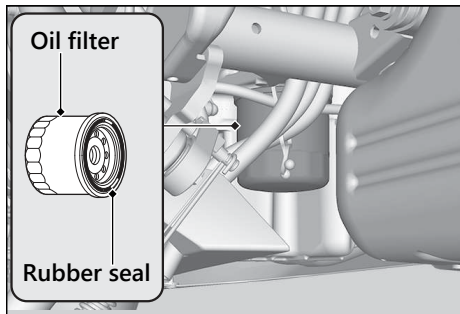

- Apply a thin coat of engine oil to the rubber seal of a new oil filter.

- Install the new oil filter and tighten.

**Torque:** 19 lbf-ft (26 N·m, 2.7 kgf-m)

- Install a new sealing washer onto the drain bolt. Tighten the drain bolt.

**Torque:** 22 lbf-ft (30 N·m, 3.1 kgf-m)

- Fill the crankcase with the recommended oil (► P. 72, ► P. 149) and install the oil fill cap/dipstick.

### Required oil

#### When changing oil & engine oil filter:

2.7 US qt (2.6 L)

#### When changing oil only:

2.4 US qt (2.3 L)

- Check the oil level. ► P. 83

- Check that there are no oil leaks.