

Side Stand

Refer to *Safety Precautions* on [page 122](#).

LEFT SIDE

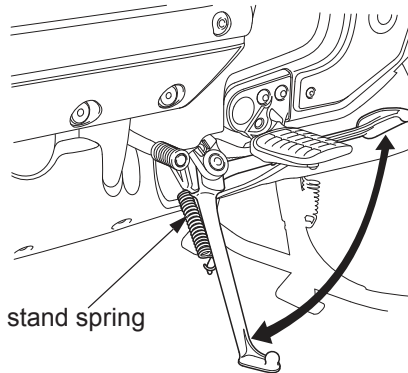

- Check that the side stand assembly is working properly. If the side stand is stiff or squeaky, clean the pivot area and lubricate the pivot bolt with clean grease.
- Check the side stand spring for damage or loss of tension.
- Check the side stand ignition cut-off system:
 1. Sit on the motorcycle and put the transmission in neutral.
 2. Raise the side stand.
 3. Start the engine.
 4. Pull the clutch lever in.
 5. Shift the transmission into gear.
 6. Lower the side stand all the way.

The engine should stop as you lower the side stand. If the engine doesn't stop, see your dealer for service.