

Accessory Power Socket

The accessory power socket is located directly behind the parking brake lever. The socket is intended for 12-volt DC accessories rated for 120 watts (10 amps) or less. Exceeding the limit can blow the accessory socket fuse (see page 184).

The socket can be used to power such items as a trouble light, spotlight, CB radio, or cell phone, but not a heat-generating accessory, such as a car cigarette lighter.

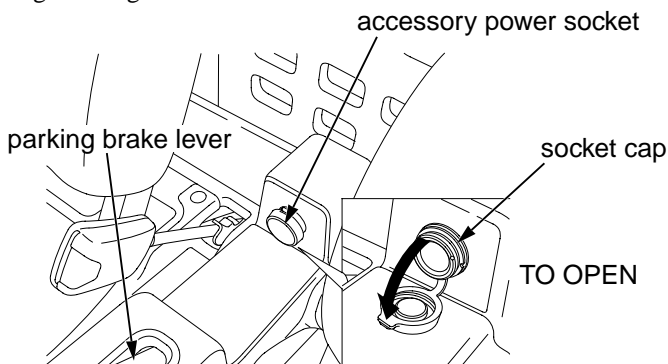

To use the accessory power socket, the engine must be on and idling.

NOTICE

Using any heat-generating accessory or improperly rated accessory can damage the socket.

Remember to close the cap when you are finished using an accessory, and keep water or other fluids away from the socket.