

Controls & Features

Ignition Switch

The ignition switch (1) is used for starting and stopping the engine (page 46). Insert the key and turn it to the right for the ON (q) position.

Key Position	Function
ON (q)	Electrical circuits on.
OFF (w)	No electrical circuits function.

CENTER OF HANDLEBAR

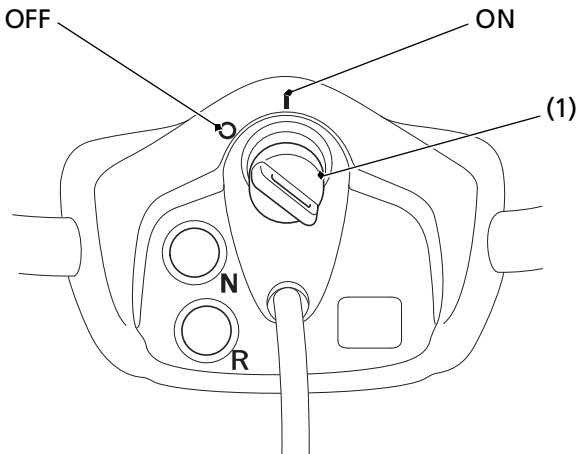

(1) ignition switch

q ON
w OFF