

Brakes

Draining Water from Brakes

Refer to *Safety Precautions* on page 79.

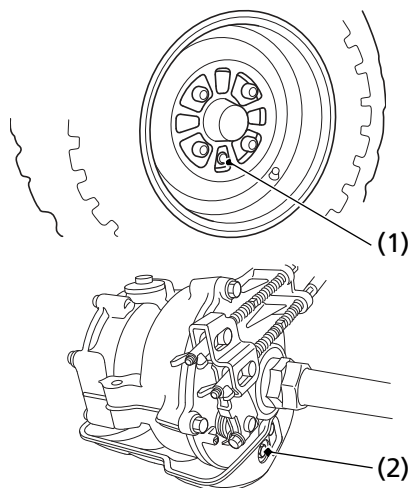

(1) front brake inspection hole plug

(2) rear brake drain bolt

1. Make sure the engine is OFF and the parking brake is set.
2. Remove the front brake inspection hole plug (1).
3. Remove the rear brake drain bolt (2) from the bottom of the rear brake cover.

If any water drains, the brake seals must be replaced by your dealer as soon as possible.