

Controls & Features

Ignition Switch

The ignition switch (1) is used for starting and stopping the engine (page 72). Insert the key and turn it to the right for the ON (q) position.

The ignition switch is also used to reset the maintenance tripmeter and the maintenance hourmeter (page 33).

Key Position	Function
ON (q)	Electrical circuits on.
OFF (w)	No electrical circuits function.

CENTER OF HANDLEBAR

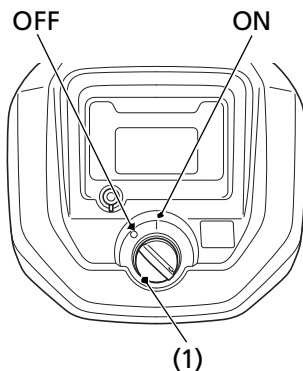

(1) ignition switch

q ON
w OFF