

# If the Transmission Is Not Functioning Properly

If the ATV does not move, even though “-” is not blinking in the gear position indicator:

If your ATV won't move, it is possible the transmission is locked. Use the following procedure to unlock the transmission.

1. Make sure the transmission is in neutral.
2. Apply the parking brake.
3. Turn the ignition switch to the OFF (w) position.
4. Loosen the screw (1) and release the lock plate (2).
5. Turn the emergency valve (3) by the screwdriver using the inside of the front fender hole (4) all the way in. With the engine running, your ATV will move forward slowly at idle.
6. See your dealer as soon as possible.

LEFT SIDE

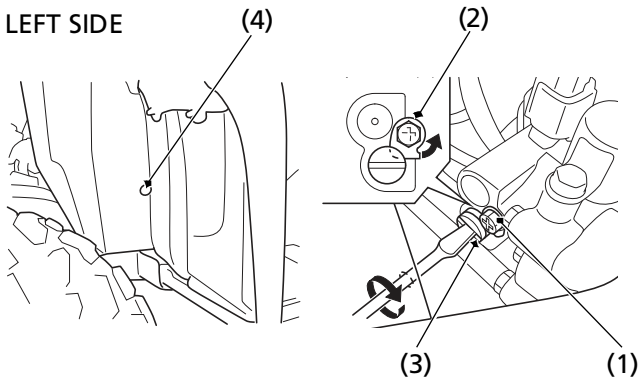

(1) screw

(2) lock plate

(3) emergency valve

(4) inside of the front fender hole

When the battery is low (or dead):

- See *If the Battery Is Low (or Dead)*, page 229.