

Battery

The battery is located in a compartment under the rear fender cover.

UNDER REAR FENDER COVER

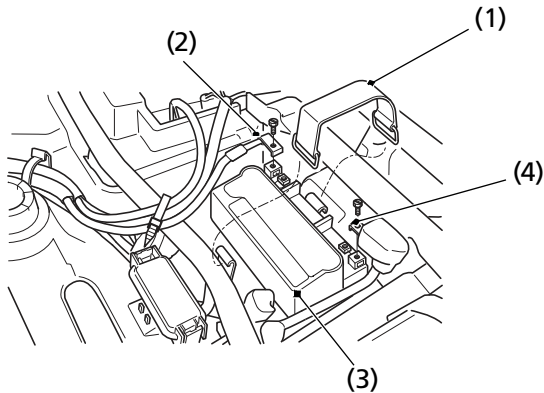

- (1) rubber band (3) battery
(2) negative (-) terminal lead (4) positive (+) terminal lead

Removal

1. Make sure the ignition switch is OFF (w).
2. Remove the seat (page 114).
3. Remove the rear fender cover (page 138).
4. Release the rings and remove the rubber band (1).
5. Disconnect the negative (-) terminal lead (2) from the battery (3) first, then disconnect the positive (+) terminal lead (4).

(cont'd)