

Starting & Stopping the Engine

Preparation

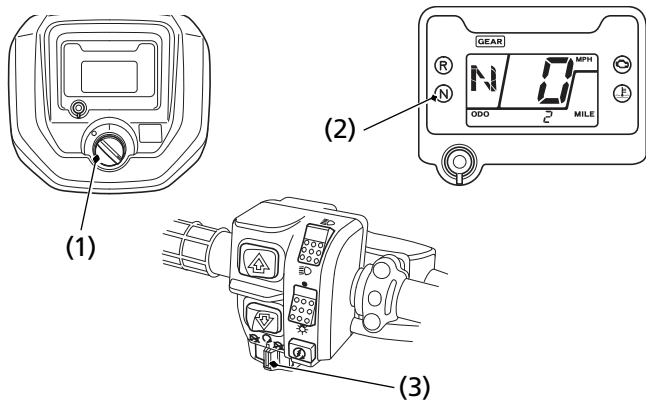

(1) ignition switch

(3) engine stop switch

(2) neutral indicator

1. Before starting, select a level surface and lock the parking brake (page 42).
2. Turn the ignition switch (1) to ON (q).

Confirm the following:

- The transmission is in neutral, and the neutral indicator (2) is ON and the gear position indicator shows "N".
- The engine stop switch (3) is set to RUN (e).