

Skid Plate & Engine Guard

Refer to *Safety Precautions* on page 103.

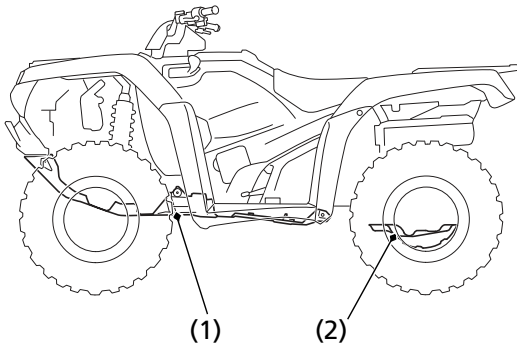

(1) engine guard

(2) skid plate

The engine guard (1) protects the frame and engine crankcase. The skid plate (2) protects the rear final gear case. Check the guard and plate for cracks, damage or looseness at intervals shown in the Maintenance Schedule.

Have the engine guard and skid plate replaced if they are cracked or damaged. If the guard and plate bolts are loose, tighten them securely.