

Drivetrain Boots

Propeller Shaft Boots & Yoke Joint Boot

Refer to *Safety Precautions* on page 111.

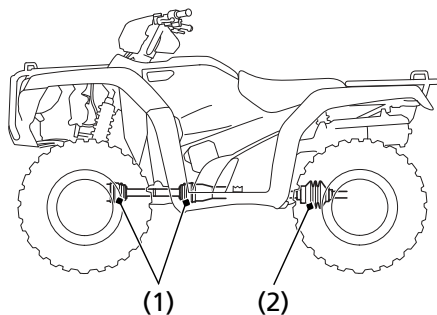

(1) propeller shaft boots

(2) yoke joint boot

Check the propeller shaft boots (1) and yoke joint boot (2) for cuts, damage or leaking grease. If necessary, have your dealer replace them.