

Engine Oil & Filter

Checking & Adding Oil

Refer to *Safety Precautions* on page 99.

Check the engine oil level each day before operating your ATV and add if needed.

Before riding your ATV, check the engine oil level.

1. Park your ATV on a firm, level surface.
2. Start the engine in a well-ventilated area and let it idle for 3–5 minutes. Stop the engine and wait 2–3 minutes.
3. Unsnap and remove the left engine sub cover (1).

LEFT SIDE

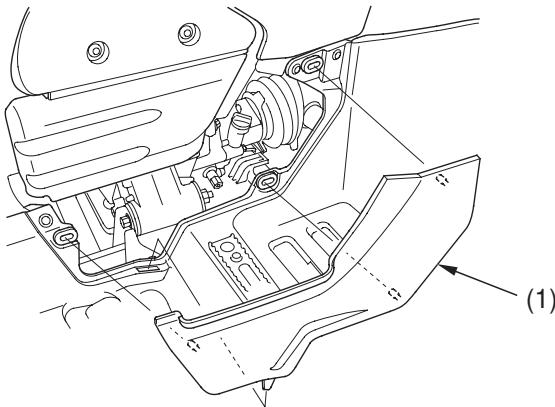

(1) left engine sub cover

(cont'd)