

Spark Arrester

Refer to *Safety Precautions* on page 99 .

The spark arrester must be serviced every 100 operating hours to maintain its efficiency.

Regular servicing prevents carbon build up (which can diminish engine performance) and also complies with USDA regulations for regular maintenance to assure proper function. The spark arrester prevents random sparks from the combustion process in your engine from reaching the environment.

1. Allow the engine and muffler to cool.
2. Remove the bolts (1), the spark arrester (2) and the gasket (3) from the muffler (4).

REAR

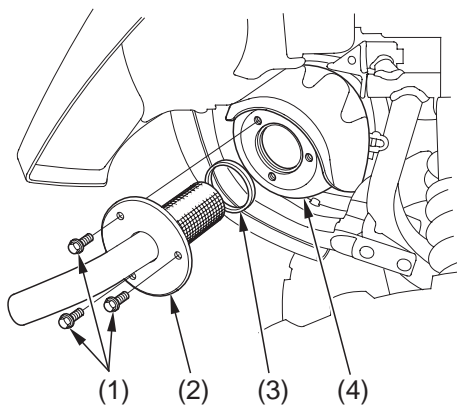

(1) bolts
(2) spark arrester

(3) gasket
(4) muffler